

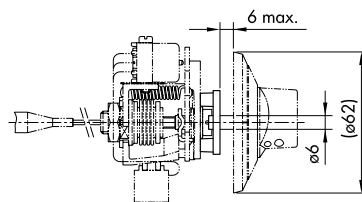

**BEFESTIGUNGEN FÜR FREI
VERLEGTES KAPILLARROHR**

**FIXATIONS POUR TUBE CAPILLAIRE À
MONTER LIBRE**

**FOR REMOTE
CAPILLARY TUBE**

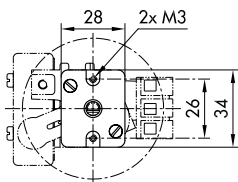

Frontbefestigung
Montage en panneau
Panel mounting

Bei Typen mit Frontplattenbefestigung ist keine Befestigung zu bestellen.
Aucune fixation supplémentaire n'est nécessaire
Do not order any mounting device for panel mounted types.

00

für Typ/ pour type/ for type
Alterostat 136 ... 145
Duostat 336 ... 345
Multistat 540, 582, 592
Laborstat 704 ... 709, 739 ... 745

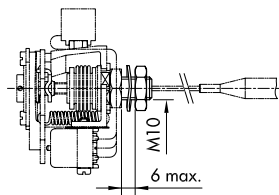

Mutter M10
Ecrou M10
Nut M10

Material : Messing vernickelt
Matière : Laiton nickelé
Material : Brass nickel plated

10

für Typ/ pour type/ for type
Alterostat 104 ... 163
Industat 404 ... 419
Multistat 558, 580, 581, 593
Ministat 604 ... 619
Laborstat 714 ... 764

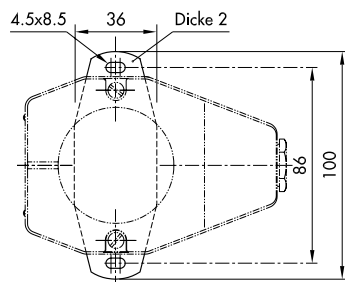
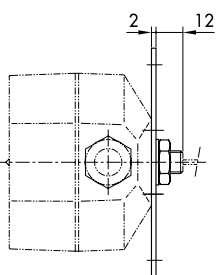

Flansch
Platine
Flange

Material : Messing vernickelt
Matière : Laiton nickelé
Material : Brass nickel plated

16

für Typ/ pour type/ for type
Industat 404 ... 472

**BEFESTIGUNGEN FÜR FREI
VERLEGTES KAPILLARROHR**

**FIXATIONS POUR TUBE CAPILLAIRE À
MONTER LIBRE**

**FOR REMOTE
CAPILLARY TUBE**

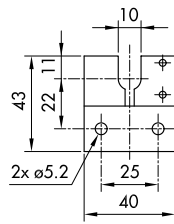
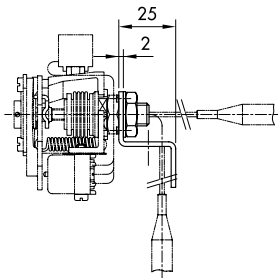

**Winkel
Angle
Angle**

Material : Stahl 1.4301
Matière : Acier 1.4301
Material : Steel 1.4301

für Typ/ pour type/ for type
Alterostat 104 ... 163
Industat 404 ... 419
Ministat 558, 593
Ministat 604 ... 619
laborstat 753 ... 764

17

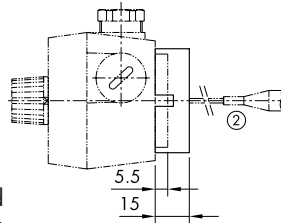
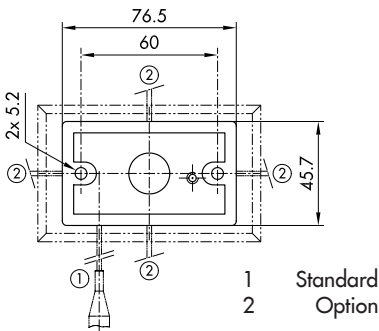

**Konsole
Socle
Console**

Material : Noryl (PPO)
Matière : Noryl (PPO)
Material : Noryl (PPO)

für Typ/ pour type/ for type
Alterostat 104 ... 119
Duostat 304 ... 319
Mini-Multistat 540, 582, 592
Ministat 604 ... 619

19

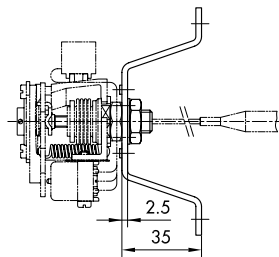
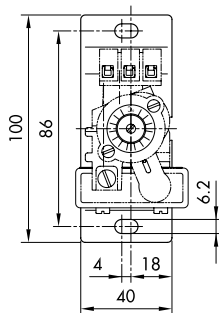

**Bügel
Platine
Bracket**

Material : Stahl verzinkt-passiviert
Matière : Acier zinguée-jaune
Material : Steel zinc coated

für Typ/ pour type/ for type
Alterostat 104 ... 163
Industat 404 ... 472
Ministat 558, 583, 593
laborstat 753 ... 764

27

**BEFESTIGUNGEN FÜR DIREKTE MON-
TAGE AUF SCHUTZROHR**

**FIXATIONS POUR MONTAGE DIRECT
SUR DOIGT DE GANT**

**FOR DIRECT PROTECTION TUBE MOUN-
TING**

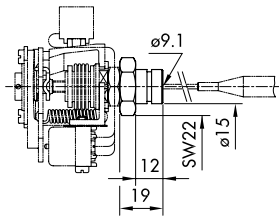

**Klemm-Befestigung, seitlich
Raccord pour vis, latérale
Grubscrew locked, lateral**

Material : Messing vernickelt
Matière : Laiton nickelé
Material : Brass nickel plated

12

für Typ/ pour Type/ for Type
Alterostat 104 ... 119
Industat 400 ... 419
Ministat 600 ... 619
Laborstat 753 ... 770

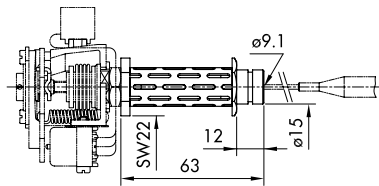

**Befestigungsmutter mit Distanzierung (Kühlelement)
Tube de refroidissement et raccord pour vis latérale
Grubscrew locked with thermal distance piece**

Material : Messing chem. vernickelt
Matière : Laiton chim. nickelé
Material : Brass chem. nickel plated

18

für Typ/ pour Type/ for Type
Alterostat 104 ... 119
Industat 400 ... 419
Ministat 600 ... 619
Laborstat 753 ... 770

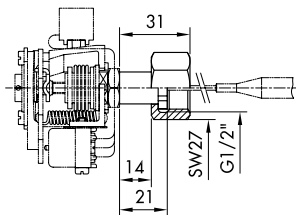

**Überwurfmutter
Ecrou mobile
Captive nut**

Material : Messing vernickelt
Stahl 1.4435
Matière : Laiton nickelé
Acier inox 1.4435
Material : Brass nickel plated
Stainless steel 1.4435

14

für Typ/ pour type/ for type
Alterostat 104 ... 119
Industat 400 ... 419
Navistat 471, 472
Picotherm 474
Ministat 600 ... 619
Laborstat 753 ... 770

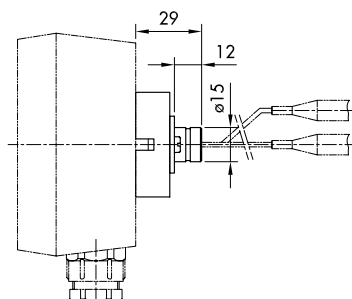

**Konsole mit Befestigungsflansch
Console avec raccord pour vis latérale
Console with grub screw locked**

Material : Messing chem. vernickelt
Matériel : Laiton chim. nickelé
Material : Brass chem. nickel plated

21

für Typ/ pour type/ for type
Duostat 300 ... 319

**BEFESTIGUNGEN FÜR DIREKTE MON-
TAGE AUF SCHUTZROHR**

**FIXATIONS POUR MONTAGE DIRECT
SUR DOIGT DE GANT**

**FOR DIRECT PROTECTION TUBE
MOUNTING**

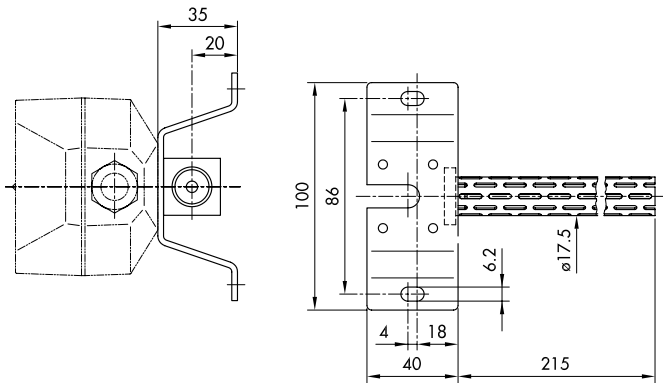

**Befestigungsbügel mit Schutzrohr
Platine avec doigt de gant
Mounting bracket with protection tube**

2743

Material : Stahl vernickelt
Matière : Acier nickelé
Material : Steel nickel plated

für Typ/ pour type/ for type
Industat 400 ... 419

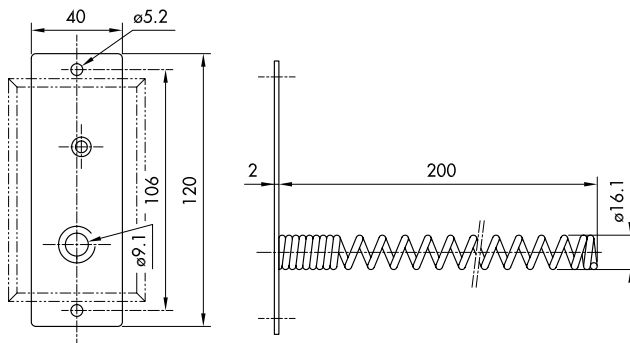

**Kanalhalterung
Fixation pour conduite
Duct mounting bracket**

30

Material : Stahl verzinkt, gelb
Matière : Acier zingué, jaune
Material : Steel zinc coated, yellow

für Typ/ pour type/ for type
Ministat 600 ... 619

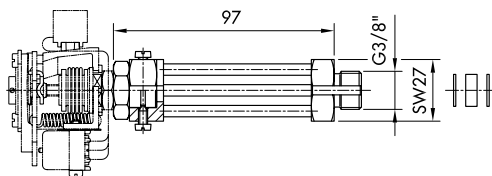

**Distanz-Befestigung (Kühlelement)
Refroidisseur
Thermal distance piece**

35

Material : Messing vernickelt
Matière : Laiton nickelé
Material : Brass nickel plated

für Typ/ pour type/ for type
Industat 400 ... 419
Labordtat 753 ... 770

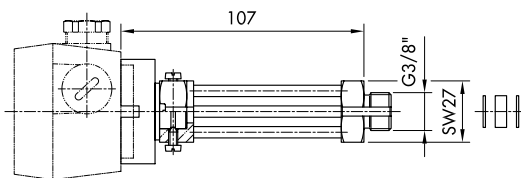

Ministat 600 ... 619



Trafag entwickelt und produziert auch speziell auf Ihre Bedürfnisse zugeschnittene Produkte. Bitte fragen Sie uns an.
Trafag développe et fabrique des produits adaptés à vos besoins spécifiques en se basant sur votre cahier des charges. Contactez-nous s.v.p.
Trafag develops and manufactures customized products according to your specifications to meet your requirements. Please contact us.