

INDUSTRIAL PRESSURE TRANSMITTER

Swiss based Trafag is a leading international supplier of high quality sensors and monitoring instruments for measurement of pressure and temperature. The economical pressure transmitter ECT 8472 is based on the tried and true ECT line of transmitters. The wide media temperature range from -25 to 125°C in combination with a comprehensive set of features and options makes the ECT 8472 pressure transmitter a versatile solution suitable for most industrial applications.



Applications

- Machine tools
- Hydraulics
- Water treatment

Features

- Excellent media compatibility
- Relative or absolute pressure measurement
- Titanium version optional
- Frontal membrane optional

Technical Data			
Measuring principle	Thick-film-on-ceramic	Accuracy @ 25°C typ.	± 0.5 % FS typ.
Measuring range	0 ... 1 to 0 ... 400 bar 0 ... 15 to 0 ... 5000 psi	Media temperature	-25°C ... +125°C 400 bar/5000 psi: -10°C ... +125°C
Output signal	4 ... 20 mA, 0 ... 5 VDC, 1 ... 6 VDC, 0 ... 10 VDC, 0.5 ... 4.5 VDC ratiom.	Ambient temperature	-25°C ... +125°C Cable PVC 22: -5°C ... +60°C Cable PUR 24: -20°C ... +70°C Cable Raychem 08: -20°C ... +100°C

01/2019

Data sheet H72324ac

Subject to change

Ordering information/type code

				8472 . XX				XX	XX	XX	XX	XX
Measuring range ¹⁾	Pressure measurement range [bar]	Over pressure [bar]	Burst pressure [bar]		Pressure measurement range [psi]	Over pressure [psi]	Burst pressure [psi]					
	0 ... 1.0	2	3	71	0 ... 15	30	40	G1				
	0 ... 1.6	3.2	4.8	73	0 ... 20	45	70	G3				
	0 ... 2.5	5	7.5	75	0 ... 30	60	90	G5				
	0 ... 4	8	12	76	0 ... 50	100	150	G6				
	0 ... 6	12	15	77	0 ... 100	200	250	G7				
	0 ... 10	20	25	78	0 ... 150	300	375	G8				
	0 ... 16	32	40	79	0 ... 250	500	625	G9				
	0 ... 25	50	75	80	0 ... 400	800	1200	H0				
	0 ... 40	80	100	81	0 ... 500	1000	1250	H1				
	0 ... 60	120	180	82	0 ... 1000	2000	3000	H2				
	0 ... 100 ⁴⁾	200	300	83	0 ... 1500 ⁴⁾	3000	4500	H3				
	0 ... 160 ⁴⁾	320	480	85	0 ... 2000 ⁴⁾	4000	6000	H5				
	0 ... 250 ⁴⁾	500	750	74	0 ... 3000 ⁴⁾	6000	9000	G4				
	0 ... 400 ^{2) 4)}	800	1000	84	0 ... 5000 ^{2) 4)}	10000	12500	H4				
Sensor	Relative pressure, Material pressure connection and housing: 1.4305 (AISI303)		57	Absolute pressure, Material pressure connection and housing: 1.4305 (AISI303) ³⁾			87					
	Relative pressure, Material pressure connection and housing: 1.4404/1.4435 (AISI316L) ⁴⁾		59	Absolute pressure, Material pressure connection and housing: 1.4404/1.4435 (AISI316L) ^{3) 4)}			89					
	Relative pressure, Material pressure connection and housing: 1.4462 (AISI318LN) ⁴⁾		52	Absolute pressure, Material pressure connection and housing: 1.4462 (AISI318LN) ^{3) 4)}			82					
	Relative pressure, titanium grade 5 ⁴⁾		53	Absolute pressure, titanium grade 5 ^{3) 4)}			83					
Pressure connection	G1/4" female										10	
	G1/4" male										17	
	G1/2" male DIN3852-A ⁴⁾										21	
	G1/2" male DIN3852-E ⁴⁾										41	
	1/4" NPT male, ANSI B1.20.1 ⁴⁾										30	
	1/8" NPT male, ANSI B1.20.1 ¹¹⁾										43	
	7/16"-20UNF male SAE4 (J1926) ⁴⁾										42	
	7/16"-20UNF male, DIN3866 ³⁾										18	
	7/16"-20UNF female SAE J512 with valve opener ³⁾										24	
	R1/4" male, DIN3858										19	
G3/4" frontal membrane ^{4) 7)}										52		
Electrical connection	Male electrical plug EN 175301-803-A (DIN43650-A), Mat. PA										05	
	Male electrical plug M12x1, 5-pole, Mat. PA (Old shape), Mat. PBT (New shape)										35	
	Male electrical plug Packard Metri Pack, Mat. PBT										51	
	Male electrical plug industrial standard (contact distance 9.4 mm), Mat. PBT										01	
	Cable PUR (Screwed cable gland PA 6-3), -20°C ... +70°C ^{5) 6)}										24	
	Cable PVC (Screwed cable gland PA 6-3), -5°C ... +60°C ^{5) 6) 9)}										22	
	Cable Raychem (Screwed cable gland PA 6-3), -20°C ... +100°C ^{3) 6) 9)}										08	
Output signal	Signal output	Load resistance		I (supply)		U (supply)						
	4 ... 20 mA	(U _{supply} -9 V) / 20 mA				9 ... 30 VDC					19	
	0 ... 5 VDC	≥ 2.5 kΩ		≤ 10 mA		10 ... 30 VDC					14	
	1 ... 6 VDC	≥ 5.0 kΩ		≤ 10 mA		10 ... 30 VDC					16	
	0 ... 10 VDC	≥ 5.0 kΩ		≤ 10 mA		15 ... 30 VDC					17	
	0.5 ... 4.5 VDC ratiometric	≥ 5.0 kΩ		≤ 10 mA		5 VDC ± 0.25 VDC ratiom.					23	

Accessories		
Seal FKM (-20°C ... +125°C)		61
Seal CR ≤ 100 bar (-25°C ... +100°C) ⁸⁾		62
Seal EPDM (-25°C ... +125°C)		63
Pressure peak damping element ø 1.0 mm, material 1.4305 ¹⁰⁾		40
Pressure peak damping element ø 0.4 mm, material 1.4305 (sensors 57, 87) resp. 1.4404 (sensors 52, 53, 59, 82, 83, 89) ¹⁰⁾		44
Female electrical connector EN 175301-803-A (DIN43650-A)/NBR, -40°C ... +90°C		58
Female electrical connector EN 175301-803-A (DIN43650-A)/Silicone, -40°C ... +125°C		56
Female electrical plug M12x1, 5-pole		33
Female electrical connector industrial standard		34
Special electrical connection: Pin 1 +, Pin 2 - (only for output signal 4 ... 20 mA and male electrical plug EN175301-803-A / DIN43650-A)		92
Special electrical connection: Pin 1 Out, Pin 2 -, Pin 3 + (only for output 14, 16, 17, 23 and male electrical plug EN175301-803-A / DIN43650-A)		98
Special electrical connection: Pin 1 +, Pin 2 -, Pin 3 Out (only for output signals 14, 16, 17, 23 and male electrical plug EN 175301-803-A / DIN 43650-A)		97
Special electrical connection: Pin 1 +, Pin 3 - (only for output 4 ... 20 mA and male electrical plug Packard Metri Pack 3-poles)		E4
Special electrical connection: Pin 1 +, Pin 2 Out, Pin 3 - (only for output signals 14, 16, 17, 23 and male electrical plug Packard Metri Pack 3-poles)		99
Special electrical connection: Pin 1 +, Pin 3 -, Pin 5 Ground (only for output signal 4 ... 20 mA and male electrical plug 35, M12x1, 5-pole)		94
Special electrical connection: Pin 1 Out, Pin 2 -, Pin 3 +, Pin 4 Ground (only for output signals 14, 16, 17, 23 and male electrical plug 01, industrial standard)		E3
Cable length 1.5 m		1M
Cable length 3.0 m		3M
Cable length 5.0 m		5M
Housing nut for electrical connection EN175301-803-A (DIN43650-A) secured with Loctite (max. 85°C)		L9
Multiple packaging ¹²⁾		VM

¹⁾ Extended overpressure as well as customized pressure ranges upon request

²⁾ Media -10°C ... +125°C

³⁾ max. 40 bar

⁴⁾ Upon request

⁵⁾ Cable length see accessories (max. length 50 m, in 5-meter sections)

⁶⁾ Protection IP68: Immersion depth max. 3 m, Media +10°C ... +35°C

⁷⁾ Not for sensors 57 and 87, only for pressure ranges ≤ 25 bar or 400 psi

⁸⁾ Only for pressure connections 10, 30, 43, 42, 18, 24, 19

⁹⁾ Pressure ranges > 16 bar (Pressure ranges ≤ 16 bar upon request)

¹⁰⁾ Not for pressure connections 10, 18, 24, 52

¹¹⁾ Only for sensors 59 and 89 and electrical connections 01, 35, 51 (others on request)

¹²⁾ The order quantity must be a multiple of 50, only for electrical connections 05 and 35



Identical construction for refrigeration: Data sheet No. H72323

Standard products (extra short lead time)

Product No.	Type Code	Pressure range [bar]	Over pressure max. [bar]	Signal output	Supply [VDC]
ECT1.0A	8472 71 5717 05 0000 0000 19 58 61	0 ... 1	3.2	4 ... 20 mA	9 ... 30
ECT1.6A	8472 73 5717 05 0000 0000 19 58 61	0 ... 1.6	3.2	4 ... 20 mA	9 ... 30
ECT2.5A	8472 75 5717 05 0000 0000 19 58 61	0 ... 2.5	5	4 ... 20 mA	9 ... 30
ECT4.0A	8472 76 5717 05 0000 0000 19 58 61	0 ... 4	8	4 ... 20 mA	9 ... 30
ECT6.0A	8472 77 5717 05 0000 0000 19 58 61	0 ... 6	12	4 ... 20 mA	9 ... 30
ECT10.0A	8472 78 5717 05 0000 0000 19 58 61	0 ... 10	20	4 ... 20 mA	9 ... 30
ECT16.0A	8472 79 5717 05 0000 0000 19 58 61	0 ... 16	32	4 ... 20 mA	9 ... 30
ECT25.0A	8472 80 5717 05 0000 0000 19 58 61	0 ... 25	50	4 ... 20 mA	9 ... 30
ECT40.0A	8472 81 5717 05 0000 0000 19 58 61	0 ... 40	80	4 ... 20 mA	9 ... 30
ECT60.0A	8472 82 5717 05 0000 0000 19 58 61	0 ... 60	120	4 ... 20 mA	9 ... 30
ECT1.0V	8472 71 5717 05 0000 0000 17 58 61	0 ... 1	3.2	0 ... 10 VDC	15 ... 30
ECT1.6V	8472 73 5717 05 0000 0000 17 58 61	0 ... 1.6	3.2	0 ... 10 VDC	15 ... 30
ECT2.5V	8472 75 5717 05 0000 0000 17 58 61	0 ... 2.5	5	0 ... 10 VDC	15 ... 30
ECT4.0V	8472 76 5717 05 0000 0000 17 58 61	0 ... 4	8	0 ... 10 VDC	15 ... 30
ECT6.0V	8472 77 5717 05 0000 0000 17 58 61	0 ... 6	12	0 ... 10 VDC	15 ... 30
ECT10.0V	8472 78 5717 05 0000 0000 17 58 61	0 ... 10	20	0 ... 10 VDC	15 ... 30
ECT16.0V	8472 79 5717 05 0000 0000 17 58 61	0 ... 16	32	0 ... 10 VDC	15 ... 30
ECT25.0V	8472 80 5717 05 0000 0000 17 58 61	0 ... 25	50	0 ... 10 VDC	15 ... 30
ECT40.0V	8472 81 5717 05 0000 0000 17 58 61	0 ... 40	80	0 ... 10 VDC	15 ... 30
ECT60.0V	8472 82 5717 05 0000 0000 17 58 61	0 ... 60	120	0 ... 10 VDC	15 ... 30

Specifications		
Accuracy	TEB typ. @ -25 ... +85°C	± 3.0 % FS typ.
	Accuracy @ 25°C typ.	± 0.5 % FS typ.
	NLH @ 25°C (BSL) typ.	± 0.2 % FS typ.
	TC zero point and span typ.	± 0.03 % FS/K typ.
	Long term stability 1 year typ.	± 0.3 % FS typ.
Electrical Data	Output / supply voltage	4 ... 20 mA: 24 (9 ... 30) VDC 0 ... 5 VDC: 24 (10 ... 30) VDC 1 ... 6 VDC: 24 (10 ... 30) VDC 0 ... 10 VDC: 24 (15 ... 30) VDC 0.5 ... 4.5 VDC ratiom.
	Rise time	Typ. 1 ms / 10 ... 90 % nominal pressure
	Switch-on-delay	Max. 1.5 s
	Inverse-polarity protection, short-circuit strength @ 25°C during 5 min.	4 ... 20 mA: to $U_s = 30$ VDC 0 ... 10 VDC, 0 ... 5 VDC, 1 ... 6 VDC: to $U_s = 30$ VDC 0.5 ... 4.5 VDC ratiometric: to $U_s = 5.25$ VDC
Environmental conditions	Media temperature	-25°C ... +125°C 400 bar/5000 psi: -10°C ... +125°C
	Ambient temperature	-25°C ... +125°C Cable PVC 22: -5°C ... +60°C Cable PUR 24: -20°C ... +70°C Cable Raychem 08: -20°C ... +100°C
	Protection ¹⁾	IP65, IP67, IP68
	Humidity	Max. 95 % relative
	Vibration	4 g (10...2000 Hz)
	Shock	50 g / 8 ms
EMC Protection	Emission	EN/IEC 61000-6-3
	Immunity	EN/IEC 61000-6-2
Mechanical Data	Sensor (wetted parts)	Ceramic, Al ₂ O ₃ (96 %)
	Pressure connection (wetted parts)	57/87: 1.4305 (AISI303) 59/89: 1.4404/1.4435 (AISI316L) 52/82: 1.4462 (AISI318LN) 53/83: Titanium Grade 5
	Housing	57/87: 1.4305 (AISI303) 59/89: 1.4404/1.4435 (AISI316L) 52/82: 1.4462 (AISI318LN) 53/83: Titanium Grade 5
	Sealing	FKM 70 Sh, CR, EPDM
	Male electrical plug	See ordering information
	Weight	~ 110 g
	Mounting torque	15 ... 20 Nm

¹⁾ See electrical connection

Measuring accuracy 0.5 %

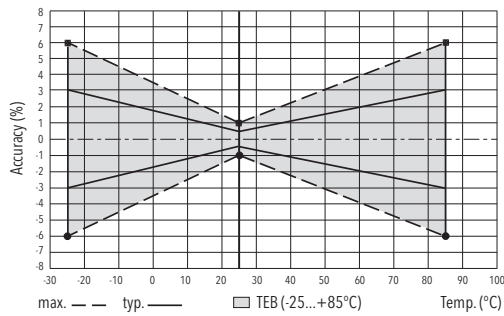

Electrical connection

		Protection / electrical connection								
		IP65*)	IP67*)	IP67*)	IP65	IP68 max. 3m	IP68 max. 3 m			
		Industrial standard EN175301-803A **)	M12x1 **)	Packard Metri Pack **)	Industrial standard Contact distance 9.4 mm **)	Cable**)	Cable **)			
		05	35	51	01	24/22	08			
Output signal	<p>8472.xx.xxxx.xx.19</p>	Standard	92	Standard	94		E4			
	<p>8472.xx.xxxx.xx.14/16/17/23</p>	Standard	98	97			99	E3		
		2	1	4	1	1	1	2	white	red
		1	2	1	3	2	3	1	brown	black
		⊕	⊖	5	5		⊕	⊕	yellow	green
		2	3	2	1	1	1	3	white	red
		3	1	3	3	2	2	1	green	white
		1	2	2	2	3	3	2	brown	black
		⊕	⊖	5			⊕	⊖	yellow	green

*) Provided female connector is mounted according to instructions

**) Ventilation via male electric plug/cable end

***) Only cable versions or female electrical plug with shield connection

Additional information

Documents

Data sheet	www.trafag.com/H72324
Instructions	www.trafag.com/H73324
Flyer	www.trafag.com/H70662

Dimensions

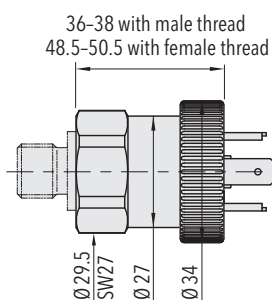

8472.XX.XXXX.05.XX.XX

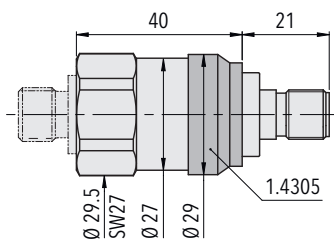

8472.XX.XXXX.35.XX.XX

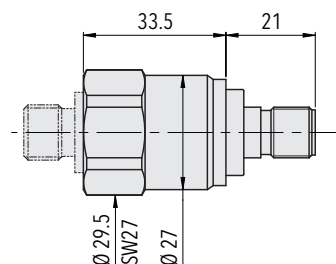

8472.XX.X717.35.XX.XX
8472.XX.X942.35.XX.XX

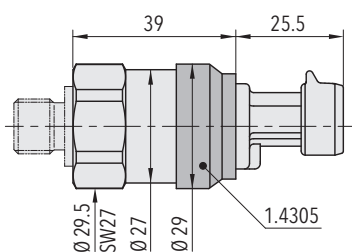

8472.XX.XXXX.51.XX.XX

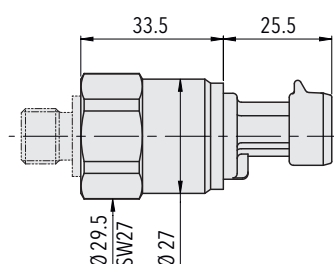

8472.XX.X717.51.XX.XX
8472.XX.X942.51.XX.XX

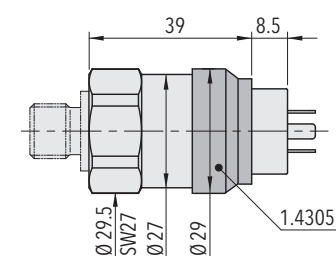

8472.XX.XXXX.01.XX.XX

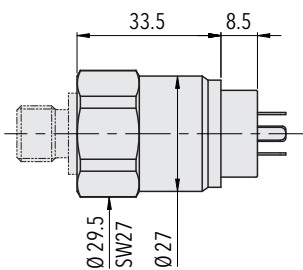

8472.XX.X717.01.XX.XX
8472.XX.X942.01.XX.XX

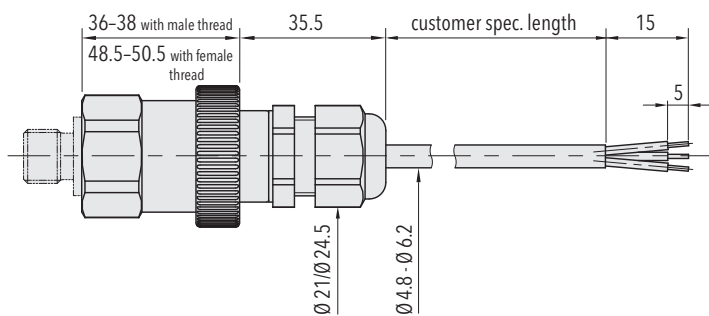

8472.XX.XXXX.22/24/08.XX.XX

Dimensions

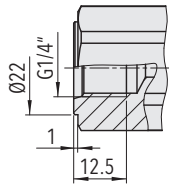

8472.XX.XX10.XX.XX.XX

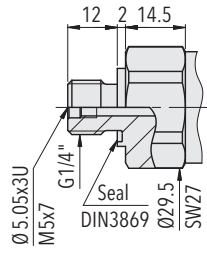

8472.XX.XX17.XX.XX.XX

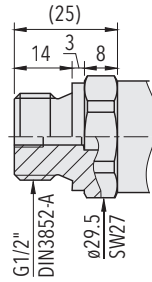

8472.XX.XX21.XX.XX.XX

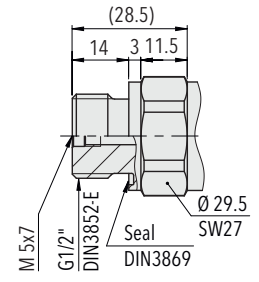

8472.XX.XX41.XX.XX.XX

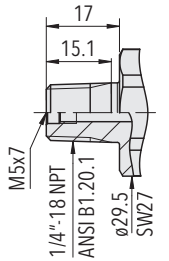

8472.XX.XX30.XX.XX.XX

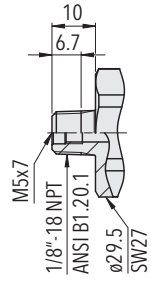

8472.XX.X943.XX.XX.XX

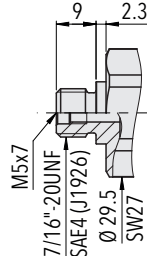

8472.XX.XX42.XX.XX.XX

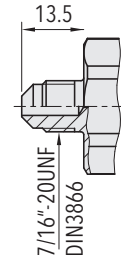

8472.XX.XX18.XX.XX.XX

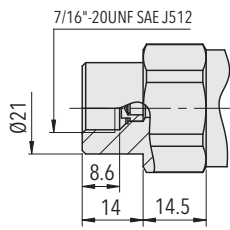

8472.XX.XX24.05.XX.XX.XX

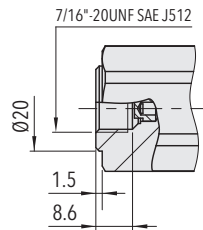

8472.XX.XX24.XX.XX.XX

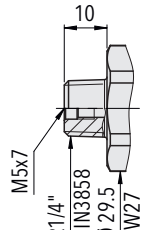

8472.XX.XX19.XX.XX.XX

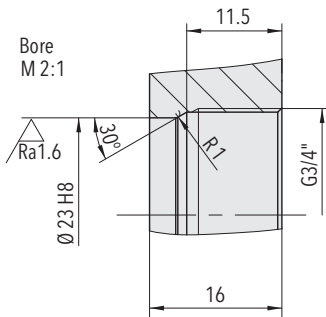

8472.XX.XX52.XX.XX.XX

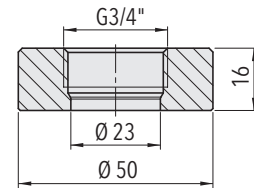
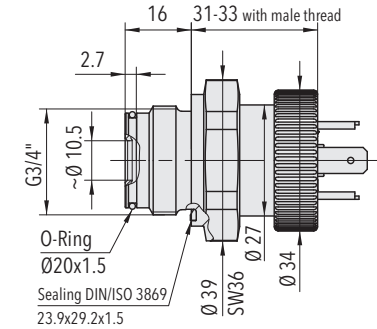

Welding flange for G3/4" frontal membrane (1.4301)
Ordering No. C27805

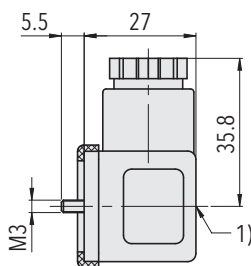

1) Tightening torque 50...60 Ncm

8472.XX.XXXX.XX.XX.56

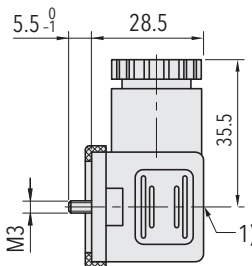

1) Tightening torque 50...60 Ncm

8472.XX.XXXX.XX.XX.58

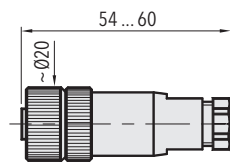

8472.XX.XXXX.XX.XX.33

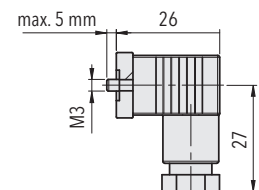

8472.XX.XXXX.XX.XX.34